

**iMilani**

innovative  
italian  
ideas

**ecodue-23**

**iMiNOW**  
MERITI IL MEGLIO... ADESSO



**NEXIT**

**VALIDITÀ**

01/07/2023 - 31/12/2023

**CASSETTE E CONTENITORI IN PLASTICA PER INDUSTRIA E LOGISTICA**

# PERSONALIZZAZIONI

## COLORI

2



MINIMO 200 PEZZI



PP <b>2X</b> giallo segnale RAL 1003	PP <b>05</b> giallo RAL 1021	PP <b>1C</b> giallo melone RAL 1028	PP <b>HE</b> arancio segnale RAL 2010	PP <b>24</b> arancio profondo RAL 2011
PP <b>2N</b> rosso carminio RAL 3002	PP <b>1G</b> rosso rubino RAL 3003	PP <b>03</b> rosso RAL 3020	PP <b>JV</b> violetto segnale RAL 4008	PP <b>3Z</b> tele magenta RAL 4010
PP <b>04</b> blu PANTONE 660C	PP <b>XB</b> turchese PANTONE 2925C	PP <b>3P</b> blu acqua RAL 5021	PP <b>27</b> blu segnale RAL 5005	PP <b>IG</b> blu zaffiro RAL 5003
PP <b>QD</b> verde foglia RAL 6002	PP <b>JW</b> verde plastica RAL 6011	PP <b>14</b> verde iMilani PANTONE 382C	PP <b>2F</b> verde chiaro RAL 6027	PP <b>02</b> verde RAL 6032
PP <b>1B</b> grigio segnale RAL 7004	PP <b>XL</b> grigio antracite RAL 7016	PP <b>08</b> grigio chiaro RAL 7035	PP <b>01</b> grigio RAL 7046	PP <b>07</b> nero RAL 9011

Colori a richiesta +7%

## MARCHIATURA

Oltre all'applicazione di etichette adesive o IML per localizzazione in radiofrequenza RFID ed identificazione con barcode, è possibile personalizzare le cassette con il Vostro logo aziendale tramite due diversi sistemi, per quantità e spedizione entro 60 gg dall'approvazione dei disegni:

- Logo in rilievo nella cassetta, ottenuto durante la fase di stampaggio, quindi dello stesso colore della cassetta
- Marchiatura a caldo ottenuta tramite caratteri mobili oppure con cliché fedele al logo aziendale.

Colori disponibili:



MINIMO 500 PEZZI

Disponibile in tutti i colori



MINIMO 100 PEZZI

PER INFO E PERSONALIZZAZIONI - RICHIEDERE PREVENTIVO

Il nuovo progetto **NEXIT** offre una gamma completa di soluzioni per ogni necessità. Ogni singola dimensione di base EURO di questo programma è declinata in diverse altezze. Ogni singola altezza prevede varianti estetiche e funzionali. Disponibile nelle serie 200x150 - 300x200 - 400x300 - 600x400 con altezze da 75 - 120 - 170 - 220 - 270 - 320 - 420 mm.

### SERIE 200x150



Dimensioni  
**200 x 150 x 75 h mm**

NX	2108A	5101
Confezione pz.	📦	32
Fondo liscio	🔘	
Prezzo unitario	<b>€ 3,01</b>	



Dimensioni  
**200 x 150 x 120 h mm**

NX	2112A	5101
Confezione pz.	📦	24
Fondo liscio	🔘	
Prezzo unitario	<b>€ 3,30</b>	

### SERIE 300x200



Dimensioni  
**300 x 200 x 75 h mm**

NX	3208A	5101
Confezione pz.	📦	20
Fondo liscio	🔘	
Prezzo unitario	<b>€ 4,12</b>	



Dimensioni  
**300 x 200 x 120 h mm**

NX	3212A	5101
Confezione pz.	📦	16
Fondo liscio	🔘	
Prezzo unitario	<b>€ 4,70</b>	

### SERIE 300x200



Dimensioni  
**300 x 200 x 170 h mm**

NX	3217A	5101
Confezione pz.	📦	12
Fondo liscio	🔘	
Prezzo unitario	<b>€ 5,38</b>	



Dimensioni  
**300 x 200 x 220 h mm**

NX	3222A	5101
Confezione pz.	📦	8
Fondo liscio	🔘	
Prezzo unitario	<b>€ 6,06</b>	



Coperchio incernierato a scatto



Coperchio separato

200x150	NX	21SE	5101
	Confezione pz.	📦	1
	Prezzo unitario	<b>€ 1,74</b>	



Coperchio incernierato

200x150	NX	21HG	5101
	Confezione pz.	📦	1
	Prezzo unitario	<b>€ 1,74</b>	



Coperchio incernierato a scatto

200x150	NX	21HH	5101
	Confezione pz.	📦	1
	Prezzo unitario	<b>€ 1,74</b>	



Portaetichette

300x200	NX	32SE	5101
	Confezione pz.	📦	1
	Prezzo unitario	<b>€ 2,42</b>	

300x200	NX	32HG	5101
	Confezione pz.	📦	1
	Prezzo unitario	<b>€ 2,42</b>	

300x200	NX	32HH	5101
	Confezione pz.	📦	1
	Prezzo unitario	<b>€ 2,42</b>	

LH	TYT
Confezione pz.	📦 10
Prezzo unitario	<b>€ 0,67</b>



CARTER DI CHIUSURA MANIGLIE INCLUSO

### SERIE 400x300



Dimensioni **400 x 300 x 75 h mm**      Dimensioni **400 x 300 x 120 h mm**      Dimensioni **400 x 300 x 120 h mm**      Dimensioni **400 x 300 x 170 h mm**      Dimensioni **400 x 300 x 170 h mm**      Dimensioni **400 x 300 x 220 h mm**

NX 4308A 5101	NX 4312A 5101	NX 4312P 5101	NX 4317B 5101	NX 4317S 5101	NX 4322B 5101
Confezione pz. 14	Confezione pz. 8	Confezione pz. 8	Confezione pz. 6	Confezione pz. 6	Confezione pz. 4
Fondo liscio	Fondo liscio	Fondo forato rinf.	Fondo liscio	Fondo forato rinf.	Fondo liscio
Prezzo unitario € 6,47	Prezzo unitario € 7,23	Prezzo unitario € 9,52	Prezzo unitario € 8,53	Prezzo unitario € 10,72	Prezzo unitario € 9,51
NX 4308C 5101	NX 4312C 5101		NX 4317D 5101		NX 4322D 5101
Fondo rinforzato	Fondo rinforzato		Fondo rinforzato		Fondo rinforzato
Prezzo unitario € 9,40	Prezzo unitario € 9,52		Prezzo unitario € 10,72		Prezzo unitario € 11,52



Sportello H220 - NX WC4322 6896

Sportello H270 - NX WC4327 6896

Dimensioni **400 x 300 x 220 h mm**      Dimensioni **400 x 300 x 220 h mm**      Dimensioni **400 x 300 x 270 h mm**      Dimensioni **400 x 300 x 270 h mm**      Dimensioni **400 x 300 x 270 h mm**      Dimensioni **400 x 300 x 320 h mm**

NX 4322S 5101	NX 4322U 5101	NX 4327B 5101	NX 4327S 5101	NX 4327U 5101	NX 4332B 5101
Confezione pz. 4	Confezione pz. 4	Confezione pz. 4	Confezione pz. 4	Confezione pz. 4	Confezione pz. 2
Fondo forato rinf.	Fondo liscio	Fondo liscio	Fondo forato rinf.	Fondo liscio	Fondo liscio
Prezzo unitario € 11,52	Prezzo unitario € 9,51	Prezzo unitario € 11,81	Prezzo unitario € 13,31	Prezzo unitario € 11,81	Prezzo unitario € 13,04
	NX WC4322 6896	NX 4327D 5101		NX WC4327 6896	NX 4332D 5101
	Confezione pz. 1	Fondo rinforzato		Confezione pz. 1	Fondo rinforzato
	Prezzo unitario € 2,09	Prezzo unitario € 13,31		Prezzo unitario € 2,28	Prezzo unitario € 14,53

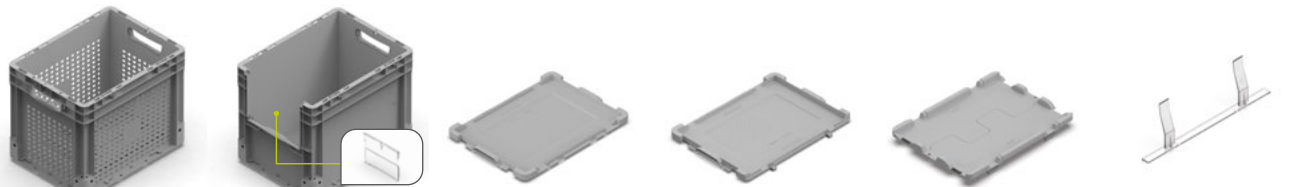

Sportello H320 - NX WC4332 6896

Dimensioni **400 x 300 x 320 h mm**      Dimensioni **400 x 300 x 320 h mm**      Coperchio separato **400 x 300**      Coperchio incernierato **400 x 300**      Coperchio a due falde **400 x 300**      Portaetichette

NX 4332S 5101	NX 4332U 5101	NX 43SE 5101	NX 43HG 5101	NX 43CR 5101	LH TYT
Confezione pz. 2	Confezione pz. 2	Confezione pz. 1	Confezione pz. 1	Confezione pz. 1	Confezione pz. 10
Fondo forato rinf.	Fondo liscio	Prezzo unitario € 4,32	Prezzo unitario € 4,32	Prezzo unitario € 8,23	Prezzo unitario € 0,67
Prezzo unitario € 14,53	Prezzo unitario € 13,04				
	NX WC4332 6896	<b>600 x 400</b>	<b>600 x 400</b>	<b>600 x 400</b>	
	Confezione pz. 1	NX 64SE 5101	NX 64HG 5101	NX 64CR 5101	
	Prezzo unitario € 2,47	Confezione pz. 1	Confezione pz. 1	Confezione pz. 1	
		Prezzo unitario € 6,98	Prezzo unitario € 6,98	Prezzo unitario € 12,52	



CARTER DI CHIUSURA MANIGLIE INCLUSO

### SERIE 600x400



Dimensioni **600 x 400 x 75 h mm**      Dimensioni **600 x 400 x 75 h mm**      Dimensioni **600 x 400 x 120 h mm**      Dimensioni **600 x 400 x 120 h mm**      Dimensioni **600 x 400 x 170 h mm**      Dimensioni **600 x 400 x 170 h mm**

NX 6408A 5101 Confezione pz. 7 Fondo liscio Prezzo unitario € 8,90	NX 6408P 5101 Confezione pz. 7 Fondo forato rinf. Prezzo unitario € 12,37	NX 6412A 5101 Confezione pz. 4 Fondo liscio Prezzo unitario € 10,25	NX 6412P 5101 Confezione pz. 4 Fondo forato rinf. Prezzo unitario € 13,42	NX 6417B 5101 Confezione pz. 3 Fondo liscio Prezzo unitario € 11,67	NX 6417S 5101 Confezione pz. 3 Fondo forato rinf. Prezzo unitario € 15,46
NX 6408C 5101 Fondo rinforzato Prezzo unitario € 12,37		NX 6412C 5101 Fondo rinforzato Prezzo unitario € 13,42		NX 6417D 5101 Fondo rinforzato Prezzo unitario € 15,46	



Dimensioni **600 x 400 x 220 h mm**      Dimensioni **600 x 400 x 220 h mm**      Dimensioni **600 x 400 x 220 h mm**      Dimensioni **600 x 400 x 270 h mm**      Dimensioni **600 x 400 x 270 h mm**      Dimensioni **600 x 400 x 270 h mm**

NX 6422B 5101 Confezione pz. 2 Fondo liscio Prezzo unitario € 15,28	NX 6422S 5101 Confezione pz. 2 Fondo forato rinf. Prezzo unitario € 18,31	NX 6422U 5101 Confezione pz. 2 Fondo liscio Prezzo unitario € 15,28	NX 6427B 5101 Confezione pz. 2 Fondo liscio Prezzo unitario € 18,66	NX 6427S 5101 Confezione pz. 2 Fondo forato rinf. Prezzo unitario € 23,32	NX 6427U 5101 Confezione pz. 2 Fondo liscio Prezzo unitario € 18,66
NX 6422D 5101 Fondo rinforzato Prezzo unitario € 18,31		NX WC6422 6896 Confezione pz. 1 Prezzo unitario € 2,28	NX 6427D 5101 Fondo rinforzato Prezzo unitario € 23,32		NX WC6427 6896 Confezione pz. 1 Prezzo unitario € 2,47



Dimensioni **600 x 400 x 320 h mm**      Dimensioni **600 x 400 x 320 h mm**      Dimensioni **600 x 400 x 320 h mm**      Dimensioni **600 x 400 x 420 h mm**      Dimensioni **600 x 400 x 420 h mm**      Dimensioni **600 x 400 x 420 h mm**

NX 6432B 5101 Confezione pz. 3 Fondo liscio Prezzo unitario € 21,01	NX 6432S 5101 Confezione pz. 3 Fondo forato rinf. Prezzo unitario € 24,24	NX 6432U 5101 Confezione pz. 3 Fondo liscio Prezzo unitario € 21,01	NX 6442B 5101 Confezione pz. 1 Fondo liscio Prezzo unitario € 28,10	NX 6442S 5101 Confezione pz. 1 Fondo forato rinf. Prezzo unitario € 30,03	NX 6442U 5101 Confezione pz. 1 Fondo liscio Prezzo unitario € 28,10
NX 6432D 5101 Fondo rinforzato Prezzo unitario € 24,24		NX WC6432 6896 Confezione pz. 1 Prezzo unitario € 2,67	NX 6442D 5101 Fondo rinforzato Prezzo unitario € 30,03		NX WC6442 6896 Confezione pz. 1 Prezzo unitario € 2,86





ECOGREEN



Fondo liscio

PORTATA 20 KG

6

### SERIE 200x150

### SERIE 300x200



Dimensioni  
200 x 150 x 75 h mm

Dimensioni  
200 x 150 x 120 h mm

Dimensioni  
300 x 200 x 75 h mm

Dimensioni  
300 x 200 x 120 h mm

Dimensioni  
300 x 200 x 170 h mm

Dimensioni  
300 x 200 x 220 h mm

NX 2108A 5401	NX 2112A 5401	NX 3208A 5401	NX 3212A 5401	NX 3217A 5401	NX 3222A 5401
Confezione pz. 32	Confezione pz. 24	Confezione pz. 20	Confezione pz. 16	Confezione pz. 12	Confezione pz. 8
Fondo liscio <input type="checkbox"/>	Fondo liscio <input type="checkbox"/>	Fondo liscio <input type="checkbox"/>	Fondo liscio <input type="checkbox"/>	Fondo liscio <input type="checkbox"/>	Fondo liscio <input type="checkbox"/>
Prezzo unitario € 2,56	Prezzo unitario € 2,80	Prezzo unitario € 3,50	Prezzo unitario € 4,00	Prezzo unitario € 4,58	Prezzo unitario € 5,15

### SERIE 400x300

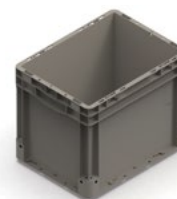
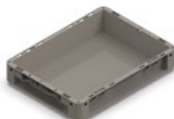

Dimensioni  
400 x 300 x 75 h mm

Dimensioni  
400 x 300 x 120 h mm

Dimensioni  
400 x 300 x 170 h mm

Dimensioni  
400 x 300 x 220 h mm

Dimensioni  
400 x 300 x 270 h mm

Dimensioni  
400 x 300 x 320 h mm

NX 4308A 5401	NX 4312A 5401	NX 4317A 5401	NX 4322A 5401	NX 4327A 5401	NX 4332A 5401
Confezione pz. 14	Confezione pz. 8	Confezione pz. 6	Confezione pz. 4	Confezione pz. 4	Confezione pz. 2
Fondo liscio <input type="checkbox"/>	Fondo liscio <input type="checkbox"/>	Fondo liscio <input type="checkbox"/>	Fondo liscio <input type="checkbox"/>	Fondo liscio <input type="checkbox"/>	Fondo liscio <input type="checkbox"/>
Prezzo unitario € 5,50	Prezzo unitario € 6,14	Prezzo unitario € 7,25	Prezzo unitario € 8,08	Prezzo unitario € 10,04	Prezzo unitario € 11,08

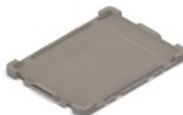

Coperchio separato

Coperchio incernierato

Coperchio incernierato  
a scatto

Coperchio separato

Coperchio incernierato

Coperchio a due falde

200 x 150

200 x 150

200 x 150

400 x 300

400 x 300

400 x 300

NX 21SE 5401	NX 21HG 5401	NX 21HH 5401	NX 43SE 5401	NX 43HG 5401	NX 43CR 5401
Confezione pz. 1	Confezione pz. 1	Confezione pz. 1	Confezione pz. 1	Confezione pz. 1	Confezione pz. 1
Prezzo unitario € 1,47	Prezzo unitario € 1,47	Prezzo unitario € 1,47	Prezzo unitario € 3,67	Prezzo unitario € 3,67	Prezzo unitario € 6,99
300 x 200			300 x 200		
NX 32SE 5401	NX 32HG 5401	NX 32HH 5401			
Confezione pz. 1	Confezione pz. 1	Confezione pz. 1			
Prezzo unitario € 2,06	Prezzo unitario € 2,06	Prezzo unitario € 2,06			



Fondo liscio

**PORTATA 20 KG**



**MANIGLIE APERTE**

H 270 - 320 - 420



**CARTER DI CHIUSURA MANIGLIE INCLUSO \***

\* forniti montati

### SERIE 600x400



Dimensioni  
**600 x 400 x 75 h mm**

NX 6408A	5401
Confezione pz.	7
Fondo liscio	<input type="checkbox"/>
Prezzo unitario	€ 7,57



Dimensioni  
**600 x 400 x 120 h mm**

NX 6412A	5401
Confezione pz.	4
Fondo liscio	<input type="checkbox"/>
Prezzo unitario	€ 8,71



Dimensioni  
**600 x 400 x 170 h mm**

NX 6417A	5401
Confezione pz.	3
Fondo liscio	<input type="checkbox"/>
Prezzo unitario	€ 9,92



Dimensioni  
**600 x 400 x 220 h mm**

NX 6422A	5401
Confezione pz.	2
Fondo liscio	<input type="checkbox"/>
Prezzo unitario	€ 12,99



Dimensioni  
**600 x 400 x 270 h mm**

NX 6427B	5401
Confezione pz.	2
Fondo liscio	<input type="checkbox"/>
Prezzo unitario	€ 15,86



Dimensioni  
**600 x 400 x 320 h mm**

NX 6432B	5401
Confezione pz.	3
Fondo liscio	<input type="checkbox"/>
Prezzo unitario	€ 17,86



Dimensioni  
**600 x 400 x 420 h mm**

NX 6442B	5401
Confezione pz.	1
Fondo liscio	<input type="checkbox"/>
Prezzo unitario	€ 23,88



Portaetichette

LH	TYT
Confezione pz.	10
Prezzo unitario	€ 0,67



Coperchio separato



Coperchio incernierato



Coperchio a due falde



Cover

NX 64SE	5401
Confezione pz.	1
Prezzo unitario	€ 5,94

NX 64HG	5401
Confezione pz.	1
Prezzo unitario	€ 5,94

NX 64CR	5401
Confezione pz.	1
Prezzo unitario	€ 10,64

NX 64CV	5401
Confezione pz.	1
Prezzo unitario	€ 6,74

# NEXIT 86

LOGISTIC



8

## SERIE 800x600



Fondo rinforzato con cornice perimetrale sandwich.

PORTATA 80 KG



Fondo rinforzato con cornice perimetrale sandwich e barre di rinforzo in acciaio.

PORTATA 200 KG



Dimensioni  
800 x 600 x 420 h mm



Dimensioni  
800 x 600 x 420 h mm



Dimensioni  
800 x 600 x 420 h mm



Dimensioni  
800 x 600 x 520 h mm

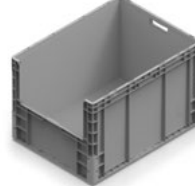

Dimensioni  
800 x 600 x 520 h mm



Dimensioni  
800 x 600 x 520 h mm

NX 8642D 5101	NX 8642T 5101	NX 8642W 5101	NX 8652D 5101	NX 8652T 5101	NX 8652W 5101
Confezione pz. 1	Confezione pz. 1	Confezione pz. 1	Confezione pz. 1	Confezione pz. 1	Confezione pz. 1
Prezzo unitario €70,00	Prezzo unitario €70,00	Prezzo unitario €70,00	Prezzo unitario €79,00	Prezzo unitario €79,00	Prezzo unitario €79,00

Coperchio separato

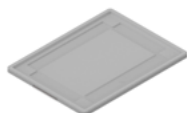

Dimensioni  
800 x 600 mm

NX 86SE 5101
Confezione pz. 1
Prezzo unitario €18,00

Coperchio a due falde



Dimensioni  
800 x 600 mm

NX 86CR 5101
Confezione pz. 1
Prezzo unitario €28,00



NX WC8642 6896
Confezione pz. 1
Prezzo unitario €7,60



NX WC8652 6896
Confezione pz. 1
Prezzo unitario €8,90

Slitta di inforcamento  
**SOLO**  
per carrello elevatore



NX RUNN2 5107
<input checked="" type="checkbox"/> Ordinare 2 pezzi
Accessori forniti montati
Prezzo unitario €11,00



slitte di inforcamento





# ATHENA 86

LOGISTIC

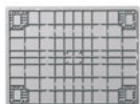

Fondo rinforzato  
**PORTATA 60 KG**



con piedini



con piedini + traverse



con ruote

## SERIE 800x600



Dimensioni  
**800 x 600 x 120 h mm**



Dimensioni  
**800 x 600 x 170 h mm**



Dimensioni  
**800 x 600 x 220 h mm**



Dimensioni  
**800 x 600 x 320 h mm**



Dimensioni  
**800 x 600 x 430 h mm**



Coperchio separato

Dimensioni  
**800 x 600 mm**

AT 8612C 5101	AT 8617C 5101	AT 8622C 5101	AT 8632C 5101	AT 8643C 5101	AT 86SE 5101
Confezione pz. 4	Confezione pz. 3	Confezione pz. 2	Confezione pz. 2	Confezione pz. 1	Confezione pz. 5
Prezzo unitario €33,25	Prezzo unitario €35,79	Prezzo unitario €37,02	Prezzo unitario €42,01	Prezzo unitario €48,58	Prezzo unitario €13,71



Piede h 100 mm



Traversa h 25 mm



Molla blocco documenti  
in acciaio



senza freno



con freno



senza freno

AT FEET 5101	AT RUNN 5101	SPRING 0099	AT WRCF 100	AT WRBT 100	AT WRCT 100
<input checked="" type="checkbox"/> Ordinare 4 piedi	<input checked="" type="checkbox"/> Ordinare 2 pezzi	Confezione pz. 10	Ruota fissa in gomma diametro 100 mm	Ruota girevole in gomma diametro 100 mm	Ruota girevole in gomma diametro 100 mm
Accessori forniti montati	Accessori forniti montati	Confezione pz. 10	<input checked="" type="checkbox"/> Ordinare 4 ruote	<input checked="" type="checkbox"/> Ordinare 4 ruote	<input checked="" type="checkbox"/> Ordinare 4 ruote
Prezzo unitario €3,96	Prezzo unitario €5,28	Prezzo unitario €0,35	Prezzo unitario €9,38	Prezzo unitario €14,84	Prezzo unitario €12,00

## SERIE 400x300



Dimensioni  
**400 x 300 x 220 h mm**

Coperchio incernierato



Dimensioni  
**400 x 300 mm**



Dimensioni  
**600 x 400 x 120 h mm**



Dimensioni  
**600 x 400 x 220 h mm**



Dimensioni  
**600 x 400 x 325 h mm**



Coperchio incernierato

Dimensioni  
**600 x 400 mm**

AT 4322A ISO	AT 43HG ISO	AT 6412A ISO	AT 6422A ISO	AT 6432A ISO	AT 64HG ISO
Confezione pz. 4	Confezione pz. 10	Confezione pz. 4	Confezione pz. 2	Confezione pz. 3	Confezione pz. 10
Prezzo unitario €14,32	Prezzo unitario €5,69	Prezzo unitario €17,25	Prezzo unitario €27,51	Prezzo unitario €35,79	Prezzo unitario €11,30

## ATHENA ISO

NON CONFORME • NON-COMPLIANT



# KRONOS

SPACE SAVER



Le cassette abbattibili **KRONOS** sono state specificatamente progettate e realizzate per ridurre sensibilmente lo spazio di ingombro quando non utilizzate e nel trasporto dei vuoti. La riduzione del loro volume fino al **75%** consente quindi un elevato risparmio nei costi di immagazzinaggio e di trasporto.

10



**RIDUZIONE DEL VOLUME  
FINO AL 75%**

## SERIE 400x300



Dimensioni  
**400 x 300 x 220 h mm**

Altezza chiusa **80 mm**

KR 4322B 5101

Confezione pz. 10

Prezzo unitario **€17,39**

## SERIE 600x400



Dimensioni  
**600 x 400 x 220 h mm**

Altezza chiusa **80 mm**

KR 6422B 5101

Confezione pz. 5

Prezzo unitario **€23,78**



Dimensioni  
**600 x 400 x 320 h mm**

Altezza chiusa **80 mm**

KR 6432B 5101

Confezione pz. 5

Prezzo unitario **€27,14**

## ABBATTIBILITÀ

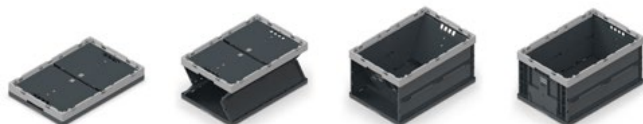

**PERSONALIZZAZIONE  
COLORE CORNICE  
SU RICHIESTA**

**MINIMO DI 200 PEZZI**  
*(con sovrapprezzo)*



## SERIE 600x400



Dimensioni  
**600 x 400 x 420 h mm**

Altezza chiusa **100 mm**

KR 6442B 5101

Confezione pz. 4

Prezzo unitario **€32,34**

## SERIE 800x400



Dimensioni  
**800 x 400 x 420 h mm**

Altezza chiusa **100 mm**

KR 8442B 5101

Confezione pz. 4

Prezzo unitario **€47,70**



Coperchio incernierato  
a due falde

KR 43HG 51XL

**400 x 300 mm**

Confezione pz. 10

Prezzo unitario **€3,73**



Coperchio incernierato  
a due falde

KR 64HG 51XL

**600 x 400 mm**

Confezione pz. 10

Prezzo unitario **€5,92**



Coperchio incernierato  
a due falde

KR 84HG 51XL

**800 x 400 mm**

Confezione pz. 10

Prezzo unitario **€8,87**



Carter di chiusura maniglie

KR PLUG 5101

Confezione pz. 10

Prezzo unitario **€0,36**



Sigillo monouso di sicurezza

KR SEAL 5113

Confezione pz. 500

Prezzo unitario **€0,11**

# DELTA

## SPACE SAVER



Le cassette serie **DELTA** presentano una struttura tronco-conica: a pieno carico sono sovrapponibili in modo stabile e sicuro, a vuoto si inseriscono l'una dentro l'altra con una riduzione del **70%** del loro volume. Per queste caratteristiche vengono utilizzate per consentire l'ideale sfruttamento degli spazi in magazzino e soprattutto nel trasporto.



**RIDUZIONE DEL VOLUME  
FINO AL 70%**

11

### VERSIONE

## A



Dimensioni **600 x 400 x 175 h mm**    Dimensioni **600 x 400 x 225 h mm**    Dimensioni **600 x 400 x 275 h mm**    Dimensioni **600 x 400 x 325 h mm**    Dimensioni **600 x 400 x 425 h mm**    Coperchio separato

DE 6417A 5101	DE 6422A 5101	DE 6427A 5101	DE 6432A 5101	DE 6442A 5101	DE 64SE 5101
Confezione pz. 5	Confezione pz. 5	Confezione pz. 5	Confezione pz. 4	Confezione pz. 3	Confezione pz. 1
Prezzo unitario <b>€13,31</b>	Prezzo unitario <b>€14,56</b>	Prezzo unitario <b>€18,01</b>	Prezzo unitario <b>€19,51</b>	Prezzo unitario <b>€25,13</b>	Prezzo unitario <b>€11,36</b>

### VERSIONE

## I



Dimensioni **600 x 400 x 180 h mm**    Dimensioni **600 x 400 x 230 h mm**    Dimensioni **600 x 400 x 280 h mm**    Dimensioni **600 x 400 x 330 h mm**    Dimensioni **600 x 400 x 430 h mm**    Sigillo monouso di sicurezza

DE 6417I 5101	DE 6422I 5101	DE 6427I 5101	DE 6432I 5101	DE 6442I 5101	DE SEAL 5113
Confezione pz. 5	Confezione pz. 5	Confezione pz. 5	Confezione pz. 4	Confezione pz. 3	Confezione pz. 500
Prezzo unitario <b>€18,60</b>	Prezzo unitario <b>€19,85</b>	Prezzo unitario <b>€23,29</b>	Prezzo unitario <b>€24,81</b>	Prezzo unitario <b>€30,45</b>	Prezzo unitario <b>€0,11</b>

### VERSIONE

## Z



Dimensioni **600 x 400 x 190 h mm**    Dimensioni **600 x 400 x 240 h mm**    Dimensioni **600 x 400 x 290 h mm**    Dimensioni **600 x 400 x 340 h mm**    Dimensioni **600 x 400 x 440 h mm**

DE 6417Z 5101	DE 6422Z 5101	DE 6427Z 5101	DE 6432Z 5101	DE 6442Z 5101
Confezione pz. 5	Confezione pz. 5	Confezione pz. 5	Confezione pz. 4	Confezione pz. 3
Prezzo unitario <b>€26,87</b>	Prezzo unitario <b>€28,12</b>	Prezzo unitario <b>€31,56</b>	Prezzo unitario <b>€33,10</b>	Prezzo unitario <b>€38,68</b>

innovative  
italian  
ideas  
**imilani**

# ZEUS

## C-PARTS



Le cassette serie **ZEUS** rispondono alle più specifiche esigenze di contenimento, movimentazione e stoccaggio delle merci. Maneggevoli, leggere e facili da pulire grazie all'interno perfettamente liscio, sono dotate di un robusto bordo che consente la sovrapposizione in modo stabile e sicuro.

12



### MISURA 701



Dimensioni  
**144 x 91 x 70 h mm**

COLORE	ZE	Z701	5101
	ZE	Z701	5102
	ZE	Z701	5103
	ZE	Z701	5104
	ZE	Z701	5105
	Confezione pz.  50		
Prezzo unitario <b>€1,50</b>			

### MISURA 702



Dimensioni  
**144 x 139 x 70 h mm**

COLORE	ZE	Z702	5101
	ZE	Z702	5102
	ZE	Z702	5103
	ZE	Z702	5104
	ZE	Z702	5105
	Confezione pz.  30		
Prezzo unitario <b>€1,83</b>			

### MISURA 272-2



Dimensioni  
**211 x 148 x 126 h mm**

COLORE	ZE	Z002	5101
	ZE	Z002	5102
	ZE	Z002	5103
	ZE	Z002	5104
	ZE	Z002	5105
	Confezione pz.  54		
Prezzo unitario <b>€3,07</b>			



### MISURA 272-3A2



Dimensioni  
**310 x 210 x 145 h mm**

COLORE	ZE	Z3A2	5101
	ZE	Z3A2	5102
	ZE	Z3A2	5103
	ZE	Z3A2	5104
	ZE	Z3A2	5105
	Confezione pz.  21		
Prezzo unitario <b>€5,41</b>			

### MISURA 272-4A2



Dimensioni  
**465 x 315 x 120 h mm**

COLORE	ZE	Z4A2	5101
	ZE	Z4A2	5102
	ZE	Z4A2	5103
	ZE	Z4A2	5104
	ZE	Z4A2	5105
	Confezione pz.  16		
Prezzo unitario <b>€9,35</b>			

### MISURA 272-4



Dimensioni  
**465 x 315 x 200 h mm**

COLORE	ZE	Z004	5101
	ZE	Z004	5102
	ZE	Z004	5103
	ZE	Z004	5104
	ZE	Z004	5105
	Confezione pz.  10		
Prezzo unitario <b>€11,51</b>			

### MISURA 272-4A5



Dimensioni  
**465 x 315 x 300 h mm**

COLORE	ZE	Z4A5	5101
	ZE	Z4A5	5102
	ZE	Z4A5	5103
	ZE	Z4A5	5104
	ZE	Z4A5	5105
	Confezione pz.  6		
Prezzo unitario <b>€15,58</b>			

# PRACTIBOX

## C-PARTS



Le cassettiere serie **PRACTIBOX** sono composte da una struttura in ABS di colore grigio e da cassette in polistirolo trasparente ad alta resistenza meccanica. Disponibili in modelli diversi, per profondità ed altezza, hanno in comune la larghezza di 600 mm che permette di sovrapporli consentendo le più svariate combinazioni. L'abbinamento con i pannelli posteriori in acciaio consente di organizzare e razionalizzare lo spazio.



Telaio posteriore per installazione a parete

PR F100 0001

600x41x1000 h mm

Prezzo unitario € 35,41

PR F150 0001

600x41x1500 h mm

Prezzo unitario € 36,39

PR F195 0001

600x41x1950 h mm

Prezzo unitario € 41,41



Cassettiere con 9 cassette

Dimensioni  
600 x 69 x 77 h mm

PR 9077 0001

Confezione pz. 2

Prezzo unitario € 15,00



Cassettiere con 6 cassette

Dimensioni  
600 x 98 x 112 h mm

PR 6112 0001

Confezione pz. 2

Prezzo unitario € 18,32



Cassettiere con 5 cassette

Dimensioni  
600 x 141 x 164 h mm

PR 5164 0001

Confezione pz. 1

Prezzo unitario € 29,16



Cassettiere con 4 cassette

Dimensioni  
600 x 174 x 206 h mm

PR 4206 0001

Confezione pz. 1

Prezzo unitario € 38,31



Cassettiere con 3 cassette

Dimensioni  
600 x 209 x 240 h mm

PR 3240 0001

Confezione pz. 1

Prezzo unitario € 44,99



Cassettiere con 2 cassette

Dimensioni  
600 x 311 x 353 h mm

PR 2353 0001

Confezione pz. 1

Prezzo unitario € 84,14



Abbinabile al telaio posteriore per posizionamento libero

Dimensioni  
600 x 300 x 100 h mm

PR DBAS 0001

Base opzionale

Prezzo unitario € 47,20



Dimensioni  
600 x 28 x 500 h mm

PR F050 0001

Pannello posteriore

Prezzo unitario € 21,90



Dimensioni  
600 x 150 x 500 h mm

PR D050 0001

Telaio da banco senza cassette

Prezzo unitario € 39,87





# COMPAT

## C-PARTS



I contenitori serie **COMPAT** sono la soluzione ideale ad ogni problema di stoccaggio: in magazzino, in officina, lungo le linee di montaggio. Consentono di avere sempre a portata di mano e ben in vista il contenuto, rendendolo prelevabile con estrema facilità.

14

### MISURA 1



Dimensioni  
**169/136 x 103 x 75 h mm**

COLORE	CO	C001	5101
	CO	C001	5102
	CO	C001	5103
	CO	C001	5104
	CO	C001	5105
	Confezione pz.  50		
Prezzo unitario <b>€1,14</b>			

### MISURA 2



Dimensioni  
**230/202x150x125hmm**

COLORE	CO	C002	5101
	CO	C002	5102
	CO	C002	5103
	CO	C002	5104
	CO	C002	5105
	Confezione pz.  54		
Prezzo unitario <b>€2,22</b>			

### MISURA 3A2



Dimensioni  
**350/296x210x145hmm**

COLORE	CO	C3A2	5101
	CO	C3A2	5102
	CO	C3A2	5103
	CO	C3A2	5104
	CO	C3A2	5105
	Confezione pz.  21		
Prezzo unitario <b>€5,30</b>			

### MISURA 3



Dimensioni  
**350/291x210x200hmm**

COLORE	CO	C003	5101
	CO	C003	5102
	CO	C003	5103
	CO	C003	5104
	CO	C003	5105
	Confezione pz.  15		
Prezzo unitario <b>€6,26</b>			



CO	C1S2	5407
Divisorio 2 scomparti per misura 1		
Confezione pz.  25		
Prezzo unitario <b>€1,39</b>		



CO	C2S2	5407
Divisorio 2 scomparti per misura 2		
Confezione pz.  25		
Prezzo unitario <b>€1,88</b>		

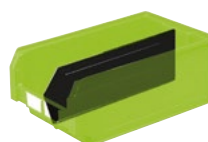

CD	C3A2	7107
Divisorio longit. in plastica per misura 3A2		
Confezione pz.  10		
Prezzo unitario <b>€2,14</b>		



CD	C003	7107
Divisorio longit. in plastica per misura 3		
Confezione pz.  10		
Prezzo unitario <b>€2,80</b>		



CO	C1S4	5407
Divisorio 4 scomparti per misura 1		
Confezione pz.  25		
Prezzo unitario <b>€1,39</b>		



CO	C2S4	5407
Divisorio 4 scomparti per misura 2		
Confezione pz.  25		
Prezzo unitario <b>€1,88</b>		



I contenitori Compat possono essere suddivisi longitudinalmente e trasversalmente per le unità di carico con più prodotti al loro interno.

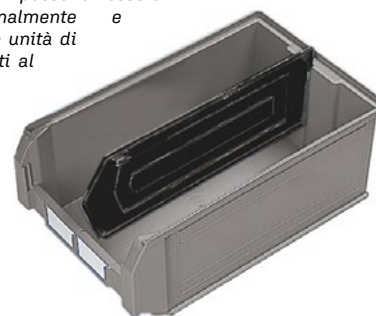

# COMPAT

## C-PARTS



I contenitori a bocca di lupo **COMPAT** sono impilabili in modo stabile e sicuro e la pronta disponibilità del materiale non viene meno anche quando sono sovrapposti. Un rinforzo laterale sul fondo permette di accatastare i contenitori con la massima sicurezza anche a pieno carico.

### MISURA 4A2



Dimensioni  
500/450 x 310 x 145 h mm

### MISURA 4



Dimensioni  
500/443 x 310 x 200 h mm

### MISURA 4A5



Dimensioni  
500/445 x 310 x 300 h mm

### MISURA 5P4



Dimensioni  
535/452 x 472 x 300 h mm

### MISURA 5



Dimensioni  
720/636 x 472 x 300 h mm

COLORE	CO	C	MISURA	5101
	CO	C4A2	5101	
	CO	C4A2	5102	
	CO	C4A2	5103	
	CO	C4A2	5104	
	CO	C4A2	5105	
	Confezione pz. 14			
	Prezzo unitario €10,79			

COLORE	CO	C	MISURA	5101
	CO	C004	5101	
	CO	C004	5102	
	CO	C004	5103	
	CO	C004	5104	
	CO	C004	5105	
	Confezione pz. 10			
	Prezzo unitario €12,23			

COLORE	CO	C	MISURA	5101
	CO	C4A5	5101	
	CO	C4A5	5102	
	CO	C4A5	5103	
	CO	C4A5	5104	
	CO	C4A5	5105	
	Confezione pz. 6			
	Prezzo unitario €14,90			

COLORE	CO	Z	MISURA	5101
	CO	Z5P4	5101	
	CO	Z5P4	5102	
	CO	Z5P4	5103	
	CO	Z5P4	5104	
	CO	Z5P4	5105	
	Confezione pz. 18			
	Prezzo unitario €27,96			

COLORE	CO	Z	MISURA	5101
	CO	Z005	5101	
	CO	Z005	5102	
	CO	Z005	5103	
	CO	Z005	5104	
	CO	Z005	5105	
	Confezione pz. 12			
	Prezzo unitario €35,35			



**CD C4A2 0099**  
Divisorio longit. zincato per misura 4A2  
Confezione pz. 1  
Prezzo unitario €7,38

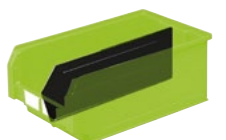

**CD C004 7107**  
Divisorio longit. in plastica per misura 4  
Confezione pz. 10  
Prezzo unitario €3,86

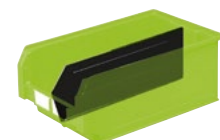

**CD C4A5 7107**  
Divisorio longit. in plastica per misura 4A5  
Confezione pz. 10  
Prezzo unitario €5,39



**CS Z5P4 0199**  
Divisorio longit. zincato con coppia supporti trasvers. mis. 5P4  
Confezione pz. 1  
Prezzo unitario €11,59



**CS Z005 0199**  
Divisorio longit. zincato con coppia supporti trasvers. mis. 5  
Confezione pz. 1  
Prezzo unitario €12,62



# COMPAT

## C-PARTS



ECOGREEN

16



### MISURA 1



Dimensioni  
**169/136 x 103 x 75 h mm**

### MISURA 2



Dimensioni  
**230/202 x 150 x 125 h mm**

### MISURA 3A2



Dimensioni  
**350/296 x 210 x 145 h mm**

### MISURA 3



Dimensioni  
**350/291 x 210 x 200 h mm**

### MISURA 4



Dimensioni  
**500/443 x 310 x 200 h mm**

CO C001 5401  
Confezione pz. 50  
Prezzo unitario **€0,89**

CO C002 5401  
Confezione pz. 54  
Prezzo unitario **€1,84**

CO C3A2 5401  
Confezione pz. 21  
Prezzo unitario **€4,55**

CO C003 5401  
Confezione pz. 15  
Prezzo unitario **€5,31**

CO C004 5401  
Confezione pz. 10  
Prezzo unitario **€10,44**



CO C1S2 5407  
Divisorio 2 scomparti  
per misura 1  
Confezione pz. 25  
Prezzo unitario **€1,39**



CO C2S2 5407  
Divisorio 2 scomparti  
per misura 2  
Confezione pz. 25  
Prezzo unitario **€1,88**

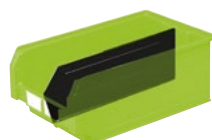

CD C3A2 7107  
Divisorio longit. in plastica  
per misura 3A2  
Confezione pz. 10  
Prezzo unitario **€2,14**



CD C003 7107  
Divisorio longit. in plastica  
per misura 3  
Confezione pz. 10  
Prezzo unitario **€2,80**



CD C004 7107  
Divisorio longit. in plastica  
per misura 4  
Confezione pz. 10  
Prezzo unitario **€3,86**



CO C1S4 5407  
Divisorio 4 scomparti  
per misura 1  
Confezione pz. 25  
Prezzo unitario **€1,39**



CO C2S4 5407  
Divisorio 4 scomparti  
per misura 2  
Confezione pz. 25  
Prezzo unitario **€1,88**



L' Ecogreen rappresenta una soluzione ecologica poiché dona nuova vita alla plastica riciclata derivante dalla valorizzazione dei rifiuti plastici da post consumo.



I carrelli portaminuteria **FOX** sono configurabili in diverse opzioni a seconda delle proprie necessità di stoccaggio. Disponibili con altezza 1430 mm, i carrelli FOX sono forniti di serie con ruote montate per facilitarne lo spostamento. Possono essere configurati in versione mono o bifronte e completati con mensole e cassette Compat, Zeus, Nextit o contenitori Practibox.



Dimensione carrello  
**1023 x 613 x 1430 h mm**

FXT B001 5401

Prezzo unitario € 522,55



Completo di:

**3 x** Mensole inclinabili - prof. 420 mm

Portata mensola **50 KG**

CONTENITORI

**9 x** NEXIT 400 x 300 x 170 H mm

**2 x** NEXIT 600 x 400 x 170 H mm



Dimensione carrello  
**725 x 613 x 1430 h mm**

FXT S001 5401

Prezzo unitario € 837,36



ECOGREEN

Completo di:

**6 x** Mensole inclinabili - prof. 220 mm

Portata mensola **50 KG**

CONTENITORI

**4 x** PRACTIBOX 6 CASSETTI + FERMI

**4 x** PRACTIBOX 5 CASSETTI + FERMI

**12 x** NEXIT 300 x 200 x 120 H mm



Dimensione carrello  
**1023 x 613 x 1430 h mm**

FXT B002 5401

Prezzo unitario € 821,02



ECOGREEN

Completo di:

**5 x** Mensole inclinabili - prof. 320 mm

Portata mensola **50 KG**

**9 x** Mensole fisse

Portata mensola **25 KG**

CONTENITORI

**45 x** COMPAT MISURA 1

**24 x** COMPAT MISURA 2

**6 x** NEXIT 400 x 300 x 120 H mm

**4 x** NEXIT 400 x 300 x 170 H mm



Dimensione carrello  
**725 x 613 x 1430 h mm**

FXT S002 5401

Prezzo unitario € 436,51



ECOGREEN

Completo di:

**3 x** Mensole inclinabili - prof. 420 mm

Portata mensola **50 KG**

CONTENITORI

**4 x** NEXIT 400 x 300 x 170 H mm

**1 x** NEXIT 600 x 400 x 170 H mm

**1 x** NEXIT 600 x 400 x 220 H mm



Dimensione carrello  
**1023 x 613 x 1430 h mm**

FXT B003 5401

Prezzo unitario € 755,36



ECOGREEN

Completo di:

**15 x** Mensole fisse

Portata mensola **25 KG**

CONTENITORI

**45 x** COMPAT MISURA 1

**24 x** COMPAT MISURA 2

**28 x** COMPAT MISURA 3A2



Dimensione carrello  
**725 x 613 x 1430 h mm**

FXT S003 5401

Prezzo unitario € 910,93



ECOGREEN

Completo di:

**14 x** Mensole inclinabili - prof. 220 mm

Portata mensola **50 KG**

CONTENITORI

**30 x** COMPAT MISURA 1

**44 x** COMPAT MISURA 2



Tutto in ordine e ben in vista per un magazzino flessibile e funzionale: questo è il risultato ottenuto dallo studio e dalla realizzazione delle cassette in polipropilene serie **RK** e degli appositi scaffali per il loro contenimento. Disponibili in undici diverse misure per rispondere ad ogni esigenza.

18

**DISPONIBILI ANCHE IN:  
PROFONDITÀ 300 / 600 mm  
ESD (CONDUTTIVO)**

### PROFONDITÀ 400 mm

### PROFONDITÀ 500 mm



Dimensioni  
**120 x 400 x 100 h mm**

Dimensioni  
**160 x 400 x 100 h mm**

Dimensioni  
**240 x 400 x 100 h mm**

Dimensioni  
**120 x 500 x 100 h mm**

Dimensioni  
**160 x 500 x 100 h mm**

Dimensioni  
**240 x 500 x 100 h mm**

RK	4012	5104	RK	4016	5104	RK	4024	5104	RK	5012	5104	RK	5016	5104	RK	5024	5104
Confezione pz.	32		Confezione pz.	24		Confezione pz.	16		Confezione pz.	32		Confezione pz.	24		Confezione pz.	16	
Prezzo unitario	€5,12		Prezzo unitario	€5,62		Prezzo unitario	€7,08		Prezzo unitario	€5,79		Prezzo unitario	€6,01		Prezzo unitario	€7,90	



Divisorio trasversale  
per cassette 4012/5012



Divisorio trasversale  
per cassette 4016/5016



Divisorio trasversale  
per cassette 4024/5024



Divisorio longitudinale  
zincato per cassette  
4016/4024



Divisorio longitudinale  
zincato per cassette  
5016/5024

RK	D120	6896	RK	D160	6896	RK	D240	6896	RK	D400	0099	RK	D500	0099
Confezione pz.	1		Confezione pz.	1		Confezione pz.	1		Confezione pz.	1		Confezione pz.	1	
Prezzo unitario	€0,76		Prezzo unitario	€0,84		Prezzo unitario	€1,34		Prezzo unitario	€3,73		Prezzo unitario	€4,28	

### PROFONDITÀ 400 mm

### PROFONDITÀ 500 mm



Dimensioni  
**120 x 400 x 100 h mm**

Dimensioni  
**160 x 400 x 100 h mm**

Dimensioni  
**240 x 400 x 100 h mm**

Dimensioni  
**120 x 500 x 100 h mm**

Dimensioni  
**160 x 500 x 100 h mm**

Dimensioni  
**240 x 500 x 100 h mm**

RK	4012	5401	RK	4016	5401	RK	4024	5401	RK	5012	5401	RK	5016	5401	RK	5024	5401
Confezione pz.	32		Confezione pz.	24		Confezione pz.	16		Confezione pz.	32		Confezione pz.	24		Confezione pz.	16	
Prezzo unitario	€4,11		Prezzo unitario	€4,48		Prezzo unitario	€5,66		Prezzo unitario	€4,62		Prezzo unitario	€4,80		Prezzo unitario	€6,32	



# RK-BOX

C-PARTS



Scaffale per la collocazione delle cassette serie **RK**. Realizzati in acciaio di colore grigio RAL 7000 - possono essere sovrapposti ed essere rialzati ed isolati dal pavimento grazie ad un apposito zoccolo in lamiera d'acciaio verniciata.

**DISPONIBILI ANCHE IN:  
PROFONDITÀ 300 e 600 mm**

19

## PROFONDITÀ 400 mm



Dimensioni  
**500 x 400 x 545 h mm**

RK	BX41	5104
16 cassette		RK 4012
Confezione pz.		☰ 1
Prezzo unitario		<b>€233,80</b>



Dimensioni  
**500 x 400 x 545 h mm**

RK	BX42	5104
12 cassette		RK 4016
Confezione pz.		☰ 1
Prezzo unitario		<b>€203,74</b>



Dimensioni  
**500 x 400 x 545 h mm**

RK	BX44	5104
8 cassette		RK 4024
Confezione pz.		☰ 1
Prezzo unitario		<b>€177,59</b>



Zoccolo profondità 400 mm

RK F400 0001

Confezione pz. ☰ 1

Prezzo unitario **€28,16**

Zoccolo profondità 500 mm

RK F500 0001

Confezione pz. ☰ 1

Prezzo unitario **€54,60**

## PROFONDITÀ 500 mm



Dimensioni  
**500 x 500 x 545 h mm**

RK	BX51	5104
16 cassette		RK 5012
Confezione pz.		☰ 1
Prezzo unitario		<b>€261,66</b>



Dimensioni  
**500 x 500 x 545 h mm**

RK	BX52	5104
12 cassette		RK 5016
Confezione pz.		☰ 1
Prezzo unitario		<b>€224,73</b>



Dimensioni  
**500 x 500 x 545 h mm**

RK	BX54	5104
8 cassette		RK 5024
Confezione pz.		☰ 1
Prezzo unitario		<b>€199,40</b>



☞ Sovrapponibili con scaffali della stessa profondità e di profondità decrescente per sfruttare al massimo lo spazio disponibile.

☞ *Completi di guide e fermi per cassette.*



*Consulta il nostro catalogo per altre configurazioni e misure disponibili.*

**imilani**  
Innovative Italian Ideas

# CONTAINER

## LOGISTIC



**CONTAINER** stampati ad iniezione e realizzati in Polietilene Alta Densità (PEHD) e rigenerato (R-PE), anche per uso alimentare. Materiale completamente riciclabile, di prima fusione garantito e certificato. Facilmente lavabile ed inattaccabile dalla ruggine; insensibile a variazioni di peso a contatto con l'acqua. Particolarmente resistente ai raggi U.V. ed infrarossi, alle alte e basse temperature, agli acidi ed alcali. Strutturato in maniera da essere impilabile, per agevolare le operazioni di stoccaggio e di movimentazione.

20



Rigenerato



Rigenerato



Rigenerato



Dimensioni  
**1000x640x655hmm**

Dimensioni  
**1000x640x655hmm**

Dimensioni  
**1165x790x800hmm**

Dimensioni  
**1165x790x800hmm**

Dimensioni  
**1165x790x800hmm**

Dimensioni  
**1165x790x800hmm**

CN 1006FJ 4001

CN 1006FJ 4007

CN 1107FJ 4001

CN 1107FJ 4007

CN 1107SJ 4001

CN 1107SJ 4007

Volume 280 L

Volume 280 L

Volume 520 L

Volume 520 L

Volume 520 L

Volume 520 L

Portata 150 kg

Portata 150 kg

Portata 250 kg

Portata 250 kg

Portata 250 kg

Portata 250 kg

Prezzo unitario € 82,65

Prezzo unitario € 67,42

Prezzo unitario € 168,02

Prezzo unitario € 140,84

Prezzo unitario € 177,26

Prezzo unitario € 148,98



**SPEDIZIONE IN 7 GIORNI**

Fornito con ruote montate



4x ruote girevoli  
Ø 100 mm senza freno

4x ruote girevoli  
Ø 125 mm senza freno

Coperchio separato

Coperchio separato

Dimensioni  
**1000x640x790hmm**

Dimensioni  
**1165x790x960hmm**

Dimensioni  
**1000 x 640 mm**

Dimensioni  
**1165 x 790 mm**

CN 1006R1J 4001

CN 1107R2J 4001

CN CV10 4001

CN CV11 4001

Volume 280 L

Volume 520 L

Confezione pz. 1

Confezione pz. 1

Portata 150 kg

Portata 250 kg

Prezzo unitario € 36,97

Prezzo unitario € 45,68

Prezzo unitario € 157,34

Prezzo unitario € 245,84



Raccolta

Batterie esauste



Raccolta

Batterie esauste

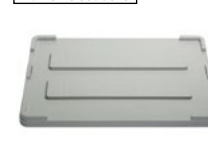

Coperchio separato

Dimensioni  
**1200x1000x760hmm**

Dimensioni  
**1200 x 1000 mm**

CN 1210BJ 4001

CN CV12 4001

Volume 610 l

Confezione pz. 1

Portata 450 kg

Prezzo unitario € 58,73

Prezzo unitario € 240,99

# TAPPETI

**AUTOMOTIVE**



Questi **TAPPETI**, realizzati in PE-LD (polietilene a bassa densità), sono particolarmente adatti nelle officine meccaniche, nelle industrie per la lavorazione del metallo, negli impianti di lavaggio, nelle industrie alimentari, nei depositi, negli stabilimenti balneari, nei camping, nei guardaroba, ecc.

## TAPPETO ANTISTRUCCIOLO CHIUSO



Dimensioni  
**800 x 400 x 25 h mm**

COLORE	CA 0804A 4101
	CA 0804A 4106
	CA 0804A 4107

Confezione pz. 4

Prezzo unitario **€17,76**

## TAPPETO ANTISTRUCCIOLO FORATO

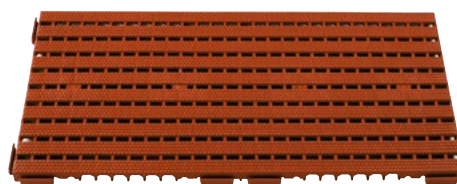

Dimensioni  
**800 x 400 x 25 h mm**

COLORE	CA 0804B 4101
	CA 0804B 4106
	CA 0804B 4107

Confezione pz. 4

Prezzo unitario **€16,41**

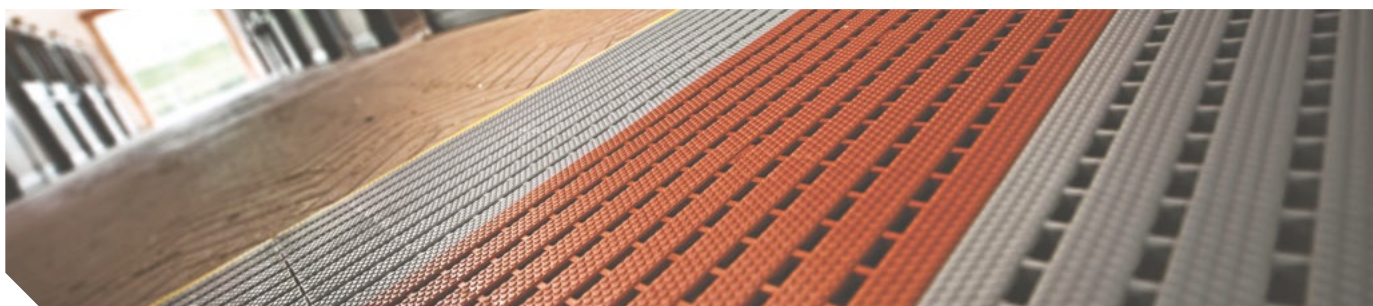

Tutte le parti possono essere unite e rimosse in modo semplice e rapido grazie all'apposito sistema di clip zincate di aggancio.

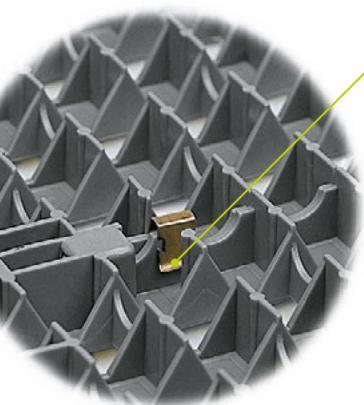

Rampa di raccordo lineare

CA 0401A 4105

**400 x 120 x 25 h mm**

Confezione pz. 20

Prezzo unitario **€3,86**



Rampa di raccordo ad angolo

CA 0101A 4105

**120 x 120 x 25 h mm**

Confezione pz. 10

Prezzo unitario **€2,16**



Clip zincata di collegamento

CA CLIP

Confezione pz. 10

Prezzo unitario **€0,20**



# SQUARE

## STEEL

RAL  
7000

Gli scaffali **SQUARE** sono sovrapponibili e possono creare vere e proprie pareti attrezzate, in base agli spazi disponibili. Gli scaffali SQUARE sono realizzati con struttura in acciaio colore grigio RAL7000, in 8 diverse configurazioni, sia per cassette serie Zeus che per contenitori serie Compat.

22



 **Contenitori esclusi**



 **Contenitori esclusi**

Dimensioni <b>1025 x 310 x 885 h mm</b>			Telai sovrapposti		Dimensioni <b>1765 x 310 x 885 h mm</b>			Telai sovrapposti	
SQ	160	03	2	max 3	SQ	280	03	2	max 3
Q.tà max cassette	16		Portata max 1+1 telai	Portata max 1+2 telai	Q.tà max cassette	28		Portata max 1+1 telai	Portata max 1+2 telai
Adatta per contenitori COMPAT	mis. 3		960 kg	640 kg	Adatta per contenitori COMPAT	mis. 3		1680 kg	1120 kg
Prezzo unitario	<b>€ 270,27</b>		Portata di ogni box	60 kg	Portata di ogni box	40 kg		60 kg	40 kg



Zoccolo

SQ B10 23

1020 x 315 x 85 h mm

Prezzo unitario **€ 65,45**



Coperchio para polvere

SQ C10 23

1020 x 315 x 20 h mm

Prezzo unitario **€ 31,44**



Zoccolo

SQ B17 63

1765 x 315 x 85 h mm

Prezzo unitario **€ 89,68**



Coperchio para polvere

SQ C17 63

1765 x 315 x 20 h mm

Prezzo unitario **€ 40,98**



 **Contenitori esclusi**

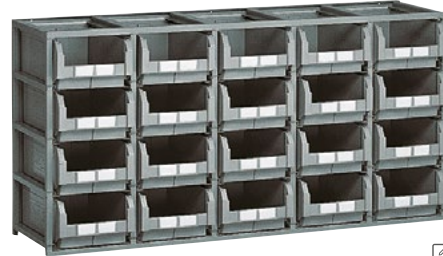

 **Contenitori esclusi**

Dimensioni <b>1075 x 460 x 885 h mm</b>			Telai sovrapposti		Dimensioni <b>1765 x 460 x 885 h mm</b>			Telai sovrapposti	
SQ	120	04	max 3		SQ	200	04	max 3	
Q.tà max cassette	12		Portata di ogni telaio		Q.tà max cassette	20		Portata di ogni telaio	
Adatta per contenitori COMPAT	mis. 4		1200 kg		Adatta per contenitori COMPAT	mis. 4		1600 kg	
ZEUS	mis. 272-4		Portata di ogni box		ZEUS	mis. 272-4		Portata di ogni box	
Prezzo unitario	<b>€ 257,92</b>		100 kg		Prezzo unitario	<b>€ 364,85</b>		80 kg	



Zoccolo

SQ B10 74

1070 x 465 x 85 h mm

Prezzo unitario **€ 76,30**



Coperchio para polvere

SQ C10 74

1070 x 465 x 20 h mm

Prezzo unitario **€ 37,40**



Zoccolo

SQ B17 64

1075 x 465 x 85 h mm

Prezzo unitario **€ 84,13**



Coperchio para polvere

SQ C17 64

1765 x 465 x 20 h mm

Prezzo unitario **€ 41,13**

# SCOPRI

## LA GAMMA DI STRUTTURE PORTA CONTENITORI IN PRONTA CONSEGNA



**QUICK**



**FRAME**



**PICK**

Disponibile con

NEXIT

KRONOS



**QUICK**



**FRAME**

Disponibile con

COMPAT

ZEUS



**PICK**

Altezze disponibili

1000 / 1655 / 2000 h mm

**RICHIEDI UN PREVENTIVO**

[www.imilani.com](http://www.imilani.com)



## Varietà



**PIÙ DI 1500 PRODOTTI  
DISPONIBILI A MAGAZZINO**

## Velocità

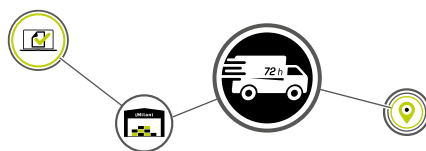

**SPEDIZIONI IN 72 ore\***  
*\* salvo disponibilità a magazzino*

## Qualità



**5 ANNI DI GARANZIA SU  
TUTTI I PRODOTTI**

# MOTION

## LOGISTIC



Carrello realizzato in polipropilene ad alto impatto, adatto al trasporto di contenitori 600x400 e 400x300. Possibilità di essere impilato quando non in uso grazie ad un semplice sistema di collegamento è possibile creare file di carrelli per un'unica movimentazione.



Dimensioni  
**594 x 396 x 173 h mm**

**MO 64TP 5107**

4 ruote girevoli  
in termoplastico grigio  
Ø 100 mm

Confezione pz. 1

Prezzo unitario **€51,11**



IMPILAGGIO



SISTEMA DI COLLEGAMENTO



**MO HELM**

Timone telescopico  
regolabile in altezza

Confezione pz. 1

Prezzo unitario **€44,15**

**iMilani**  
innovative  
italian  
ideas

**iMilani srl - SB**

Via Capitano Alessio, 109  
36027 Rosà (VI) - Italy

Tel +39 0424 583100  
info@imilani.it  
www.imilani.com

A brand of:  
**i'M**



**RICHIEDI IL CATALOGO GENERALE**